

J-Series Air-Driven Liquid Pump

S216-J, JB

The Sprague Products J-series air-driven liquid pump is an efficient, time tested design that provides users with cost-effective and energy-saving benefits by using compressed air or inert gas as the power source.

Features:

- Air-driven
- Non-electric control, non-sparking
- Pressure compensating
- Automatic restarts
- All stainless wetted section
- Suitable for water, oil and a wide range of liquids

Applications:

- Hydrostatic testing of hose, pipe, tubing, pressure gauges, cylinders, transducers, valves, tools, tanks, pressure vessels and leak testing
- Hydraulic operation such as punch and pin presses, clamping devices, chucks and valve actuation
- Tooling and tightening functions such as bolt tensioning and torque wrenches
- Lifting tables, beam jacket and aircraft jacking



Specifications

Liquid:	
Pressure Range	
J-Series Pump	9100 PSI max
Ratios (nominal)	10:1, 20:1, 30:1, 35:1, 60:1, 100:1
JB-Series Pump	
	36,500 PSI max
Ratios (nominal)	35:1, 60:1, 100:1, 101:1, 125:1, 150:1, 200:1, 300:1
Wetted Parts	
Liquid Body	303 Stainless Steel
Liquid Piston	416 Stainless Steel / chrome plated
Check Valve Body	416 Stainless Steel
Check Valve Poppet	17-4 Stainless Steel
Check Valve Springs	302 Stainless Steel
Inlet Connection	
10,000 PSI and Below	3/8" NPT female
Above 10,000 PSI	1/4" NPT female
Outlet Connection	
10,000 PSI and Below	3/8" NPT female
Above 10,000 PSI	1/4" HPCT female
Seal Options	
JB Severe Duty	PEEK Bushing with Polyurethane piston seal (Std)
Seal Options	Nitrile (Std), Neoprene, Fluorocarbon (Viton), Ethylene Propylene (EPR)

Air-Drive:	
Pressure Range	100 PSI max
Air-Drive Motor	6" Air-Drive Motor - Snap Action Pilot Valve
Air-Drive Connection	1/2" NPT female
Seal Options	Non-Lubricated
Air-Drive Control	
Air regulator setting is proportional to liquid outlet pressure	
Air-drive SCFM is proportional to pump liquid flow rate	
Special Options	
High Output Air-drive transfer tube – JB only	
Fluid Inlet/Outlet ports reversed	
Reservoir - 1 Gallon	
Separated - drive-air protection	
Dimensions	
Standard	8.13" x 8.13" x 9.75"
Separated	16.25" x 8.25" x 9"
Reservoir	15.9" x 8.13" x 11.13"
Shipping Weight	
Standard	19 LBS
Separated	24 LBS
Reservoir	21 LBS

The Sprague positive-displacement pump converts air-drive pressure into hydraulic discharge pressure. The pump uses low pressure air or inert gas to drive a large area piston which then drives a small area liquid piston that produces high hydraulic pressure. As the ratio between the air-drive piston and the liquid piston increases, higher pressures can be achieved.

In operation, the Sprague pump reciprocates rapidly until the system's liquid pressure nears the desired level, as determined by the air regulator setting, and then slows to a stop when the liquid discharge and air-drive forces reach equilibrium (pump stalls/stops). This liquid-air balance is maintained indefinitely in a holding condition with minimal energy consumption and with no increase in fluid temperature or parts movement. The pump will automatically restart if the liquid discharge pressure degrades or the inlet air-drive pressure is increased.

J-Series Pump Performance

Reference Chart

- 1 – Select liquid discharge pressure required = 400 PSI
- 2 – Determine air-drive pressure required = 40 PSI
- 3 – Determine maximum recommended flow rate = 390 IN³/MIN
- 4 – Determine SCFM required = 18.1 SCFM at maximum flow rate

J-Pump 10:1 Nominal Ratio 10.3 actual ratio

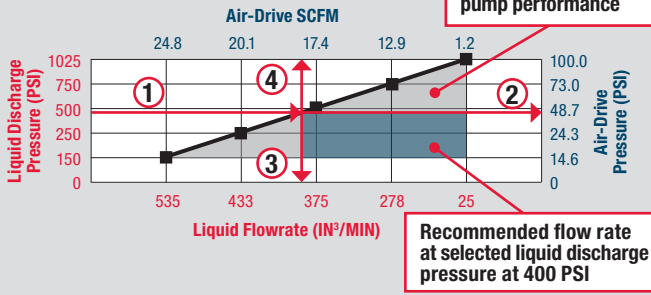

- Note: a) 15 PSI air-drive minimum for J, JB pumps
 b) 25 PSI air-drive minimum with – N option (non-lubricated)
 c) Liquid outlet pressure controlled by air-drive regulator pressure setting
 d) Air control and Liquid control valve sizing will affect pump performance
 e) 400 cycles/minute max – intermittent and start up only

J-Pump 10:1 Nominal Ratio – 10.3 actual ratio

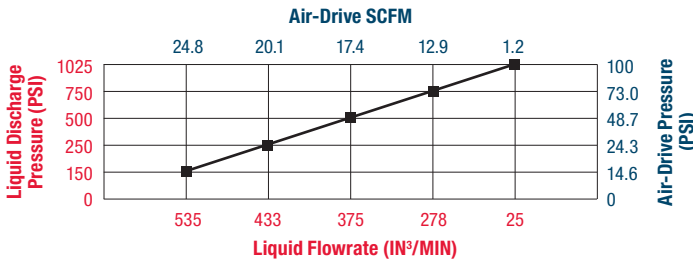

Liquid Discharge Pressure (PSI)	Liquid Flowrate (IN ³ /MIN)	Air-Drive Pressure (PSI)	Air-Drive SCFM
150	535	14.6	24.8
250	433	24.3	20.1
375	375	48.7	17.4
487	278	73.0	12.9
730	25	99.8	1.2

J-Pump 20:1 Nominal Ratio – 19.1 actual ratio

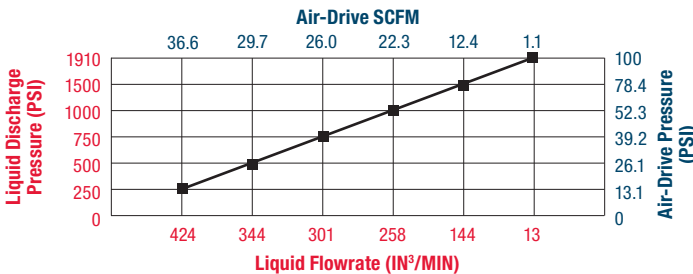

Liquid Discharge Pressure (PSI)	Liquid Flowrate (IN ³ /MIN)	Air-Drive Pressure (PSI)	Air-Drive SCFM
250	424	13.1	36.6
500	344	26.1	29.7
750	301	39.2	26.0
1000	258	52.3	22.3
1500	144	78.4	12.4
1910	13	99.9	1.1

J-Pump 30:1 Nominal Ratio – 32.1 actual ratio

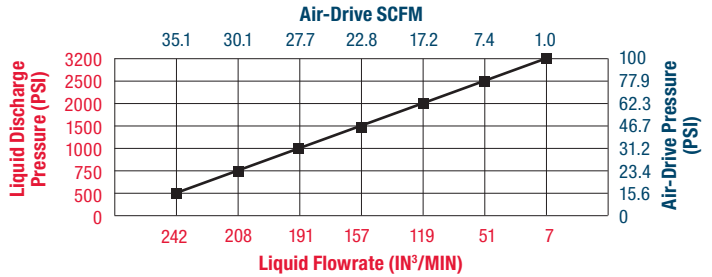

Liquid Discharge Pressure (PSI)	Liquid Flowrate (IN ³ /MIN)	Air-Drive Pressure (PSI)	Air-Drive SCFM
500	242	15.6	35.1
750	208	23.4	30.1
1000	191	31.2	27.7
1500	157	46.7	22.8
2000	119	62.3	17.2
2500	51	77.9	7.4
3200	7	99.7	1.0

J and JB Pumps 35:1 Nominal Ratio – 47.4 actual ratio

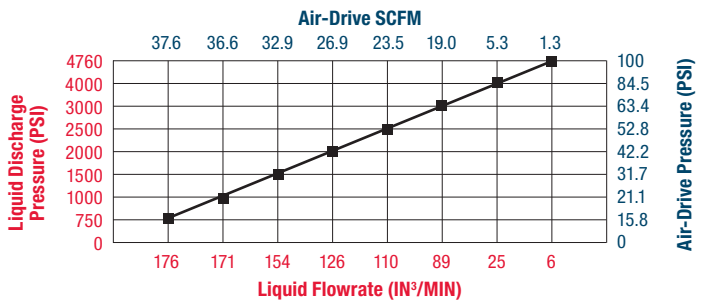

Liquid Discharge Pressure (PSI)	Liquid Flowrate (IN ³ /MIN)	Air-Drive Pressure (PSI)	Air-Drive SCFM
750	176	15.8	37.6
1000	171	21.1	36.6
1500	154	31.7	32.9
2000	126	42.2	26.9
2500	110	52.8	23.5
3000	89	63.4	19.0
4000	25	84.5	5.3
4760	6	100	1.3

J and JB Pumps 60:1 Nominal Ratio – 63.7 actual ratio

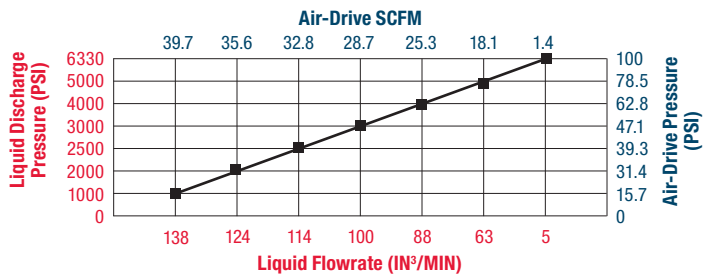

Liquid Discharge Pressure (PSI)	Liquid Flowrate (IN ³ /MIN)	Air-Drive Pressure (PSI)	Air-Drive SCFM
1000	138	15.7	39.7
2000	124	31.4	35.6
2500	114	39.3	32.8
3000	100	47.1	28.7
4000	88	62.8	25.3
5000	63	78.5	18.1
6330	5	99.4	1.4

J-Series Pump Performance (cont.)

J and JB Pumps 100:1 Nominal Ratio – 91.7 actual ratio

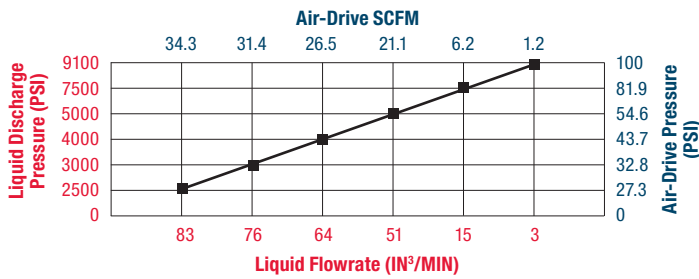

Liquid Discharge Pressure (PSI)	Liquid Flowrate (IN³/MIN)	Air-Drive Pressure (PSI)	Air-Drive SCFM
2500	83	27.3	34.3
3000	76	32.8	31.4
4000	64	43.7	26.5
5000	51	54.6	21.1
7500	15	81.9	6.2
9100	3	99.4	1.2

JB Pump 150:1 Nominal Ratio – 163.3 actual ratio

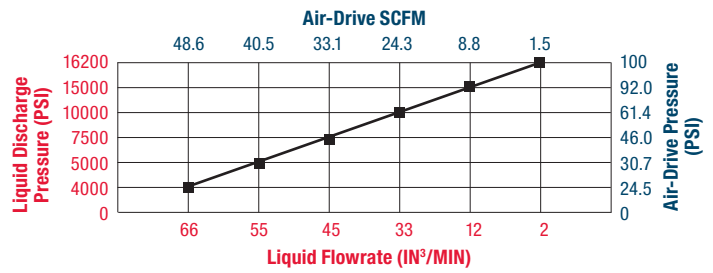

Liquid Discharge Pressure (PSI)	Liquid Flowrate (IN³/MIN)	Air-Drive Pressure (PSI)	Air-Drive SCFM
4000	66	24.5	48.6
5000	55	30.7	40.5
7500	45	46.0	33.1
10000	33	61.4	24.3
15000	12	92.0	8.8
16200	2	99.4	1.5

JB Pump 101:1 Nominal Ratio – 100:1 actual ratio

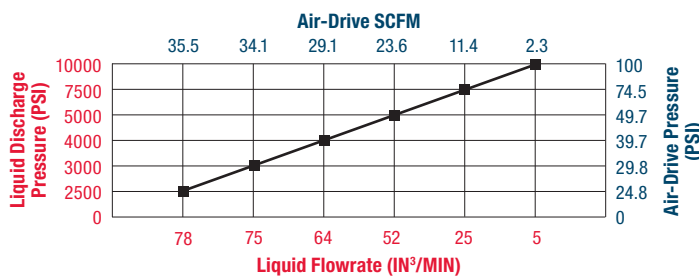

Liquid Discharge Pressure (PSI)	Liquid Flowrate (IN³/MIN)	Air-Drive Pressure (PSI)	Air-Drive SCFM
2500	78	24.8	35.5
3000	75	29.8	34.1
4000	64	39.7	29.1
5000	52	49.7	23.6
7500	25	74.5	11.4
10000	5	99.3	2.3

JB Pump 200:1 Nominal Ratio – 254.0 actual ratio

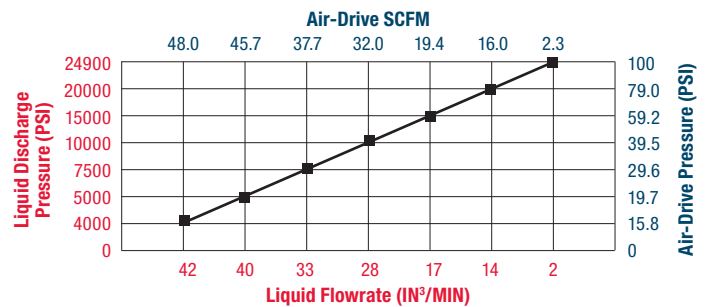

Liquid Discharge Pressure (PSI)	Liquid Flowrate (IN³/MIN)	Air-Drive Pressure (PSI)	Air-Drive SCFM
4000	42	15.8	48.0
5000	40	19.7	45.7
7500	33	29.6	37.7
10000	28	39.5	32.0
15000	17	59.2	19.4
20000	14	79.0	16.0
24900	2	98.3	2.3

JB Pump 125:1 Nominal Ratio – 125.1 actual ratio

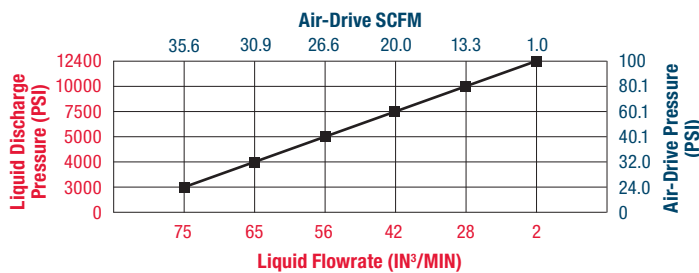

Liquid Discharge Pressure (PSI)	Liquid Flowrate (IN³/MIN)	Air-Drive Pressure (PSI)	Air-Drive SCFM
3000	75	24.0	35.6
4000	65	32.0	30.9
5000	56	40.1	26.6
7500	42	60.1	20.0
10000	28	80.1	13.3
12400	2	99.4	1.0

JB Pump 300:1 Nominal Ratio – 366.3 actual ratio

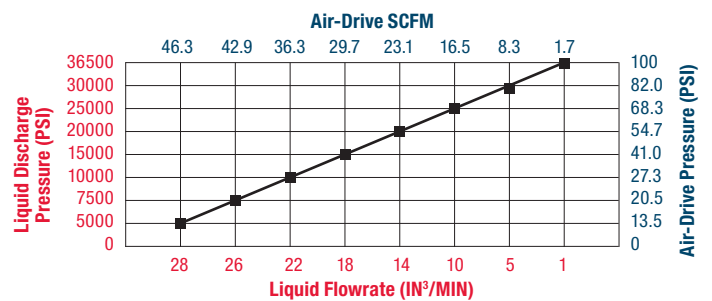

Liquid Discharge Pressure (PSI)	Liquid Flowrate (IN³/MIN)	Air-Drive Pressure (PSI)	Air-Drive SCFM
5000	28	13.5	46.3
7500	26	20.5	42.9
10000	22	27.3	36.3
15000	18	41.0	29.7
20000	14	54.7	23.1
25000	10	68.3	16.5
30000	5	82.0	8.3
36500	1	99.8	1.7

Model Code

		S216	JB	S	N	R	100	HO	NIT	-7
S216	Sprague High Pressure Pump with 6" Air-Drive Motor									Blank Std 7 Fluid Inlet/Outlet Opposite
JB	PEEK Bushing (35:1 ratios and higher)- Polyurethane seal									Blank Std – Nitrile (Polyurethane JB)
J	Classic series J-Pump (not available above 10,000 PSI)									NEO Neoprene VIT Fluorocarbon EPR Ethylene Propylene
	Blank Std									Blank Std
S	Separated - Not available with "R" option									HO High Output Air-Drive – JB Only
	Blank Std									
N	Non-Lubricated Air									
	Blank Std									
R	Reservoir 1 gallon - Not available with "S" option									
Nominal Ratio (typical pressure at 100 PSI (7 bar) drive air)										
10	1025 PSI (71 bar) output - NPT connections									
20	1910 PSI (132 bar) output - NPT connections									
30	3200 PSI (221 bar) output - NPT connections									
35	4760 PSI (328 bar) output - NPT connections									
60	6330 PSI (436 bar) output - NPT connections									
100	9100 PSI (627 bar) output - NPT connections									
101	10000 PSI (690 bar) output - NPT connections - JB only									
125	12400 PSI (855 bar) output - NPT inlet, HPCT outlet - JB only									
150	16200 PSI (1117 bar) output - NPT inlet, HPCT outlet - JB only									
200	24900 PSI (1717 bar) output - NPT inlet, HPCT outlet - JB only									
300	36500 PSI (2517 bar) output - NPT inlet, HPCT outlet - JB only									

Dimensions							
Model Number	Displacement (Per Stroke) IN ³ /MIN	Max Pressure PSI (100 PSI Air-Drive)	A	B	C – Fluid Inlet Port	D – Fluid Outlet Port	E
S-216-J-010	3.26	1,025	2.91"	2.91"	3/8 NPTF	3/8 NPTF	3.50"
S-216-J-020	1.75	1,910	2.75"	2.75"			3.25"
S-216-J-030	1.04	3,200	2.38"	2.38"			2.50"
S-216-J/JB-035	0.708	4,760					
S-216-J/JB-060	0.527	6,330					
S-216-J/JB-100	0.366	9,100					
S-216-JB-101	0.330	10,000	2.31"	2.35"	1/4 HPCT (9/16-18 UNF thread see port detail)		
S-216-JB-125	0.266	12,400					
S-216-JB-150	0.205	16,200					
S-216-JB-200	0.132	24,900					
S-216-JB-300	0.092	36,500					

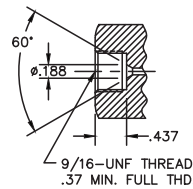
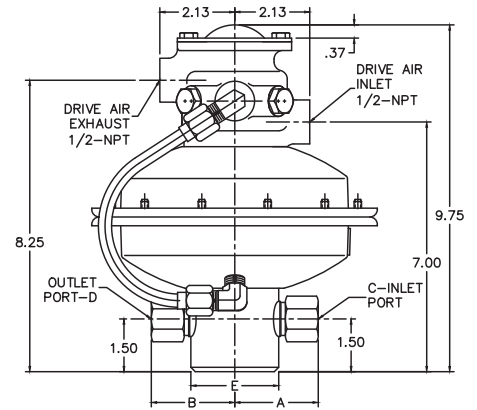

1/4 HPCT PORT DETAIL

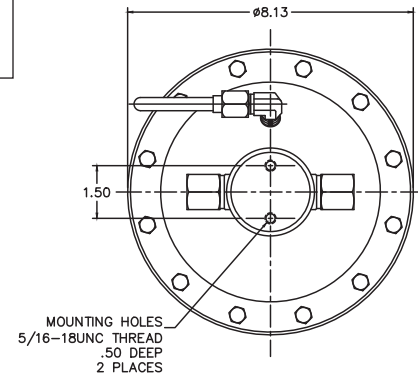

**CURTISS-
WRIGHT**

Sprague Products, a business unit of Curtiss-Wright

U.S.A.: Curtiss-Wright, 10195 Brecksville Rd, Brecksville, OH 44141, USA • Tel: 440-838-7690 • Fax: 440-838-7528 • www.cw-valvegroup.com/sprague

UK: Curtiss-Wright, Unit 4, Darwin Rd, Willowbrook Industrial Estates, Corby, NN17 5XZ, UK • Tel: +44 1536 425980 • Fax: +44 1536 425981

China: Curtiss-Wright, Rm 3709, China World Office 1, No 1 Jian Guo Men Wai Avenue, Beijing, 100004, China • Tel: 86(10)6505 8966 • Fax: 86(10)6505 0966

While this information is presented in good faith and believed to be accurate, Sprague Products, part of the Farris Engineering division of Curtiss-Wright Flow Control Corporation, does not guarantee satisfactory results from reliance on such information. Nothing contained herein is to be construed as a warranty or guarantee, expressed or implied, regarding the performance, merchantability, fitness or any other matter with respect to the products, nor as a recommendation to use any product or process in conflict with any patent. Sprague Products, division of Curtiss-Wright Flow Control Corporation, reserves the right, without notice, to alter or improve the designs or specifications of the products described herein.